



PARKING MANUAL

Part I

ADOPTED APRIL 1, 1987



CITY OF FRESNO
DEPARTMENT OF PUBLIC WORKS
2600 FRESNO STREET
FRESNO, CA. 93721-3623

TABLE OF CONTENTS

PURPOSE

1.	PARKING SPACE DIMENSIONS		
	A.	Passenger Vehicle Parking Space	1
	B.	Truck Loading Spaces	2
2.	DESIGN CRITERIA		
	A.	Driveway Approach Construction Standards	2
	B.	Backing onto Public Rights-of-Way	2
	C.	Access to Parking Spaces	3
	D.	Traffic Circulation Signing and Markings	3
	E.	Surface Requirements	4
	F.	Delineation of Parking Spaces	4
	G.	Physical Barriers	4
	H.	Landscaping	5
	I.	Lighting	5
	J.	Maintenance of Parking Facilities and Equipment	6
	K.	Parking Lot Design	6
3.	CRITERIA TO DETERMINE BASIC STALL SIZE		6
4.	ACCESSIBLE PARKING STALLS		8
5.	TABLES OF DESIGN DIMENSIONS FOR VARIOUS PARKING ANGLES		9-16
6.	DESIGN DIMENSIONS (STANDARD STALLS)		17
7.	FULL-TURN DETAIL FOR 65 DEGREES OR LESS PARKING ANGLE (STANDARD STALLS)		18
8.	FULL-TURN DETAIL FOR MORE THAN 65 DEGREES PARKING (STANDARD STALLS)		19

PURPOSE

The purpose of this manual is to present the design standards to regulate the development of off-street parking facilities in the City of Fresno.

The design standards contained herein represent minimum requirements necessary for providing adequately developed parking facilities. For the greater part, these have been taken from the Zoning Ordinance and the Standard Specifications of the Public Works Department. In addition, standards have been developed for those special situations which have not been covered by the above two sources.

These standards deal with the method of parking vehicles in an off-street facility. In designing the parking for a given zoning or use, the Zoning Ordinance should be consulted to determine the number of parking spaces required. In addition, the developer is urged to conduct an independent parking study to determine whether these minimum standards are adequate to meet the parking demands of his specific development.

Subsection 5 of Section 12-306-I of the Fresno Municipal Code provides that the standards required in this manual shall be followed.

PARKING DESIGN STANDARDS

1. PARKING SPACE DIMENSIONS

A. Passenger Vehicle Parking Space

There are two basic passenger vehicle parking space dimensions. 9' x 19' standard painted stalls and 8-1/2' x 16-1/2' small car (compact) painted stalls. Any parking lot or structure may install these basic stalls in accordance with criteria defined on page 6, Section 3. Should a property owner wish to reduce the two basic stall sizes by designating exclusive employee parking areas or by constructing continuous concrete curbs, the two basic stall sizes may be reduced in size. The eight cases defined below reflect dimensions for standard and small car stalls, stalls with continuous concrete curbs, and stalls designated for exclusive employee parking areas.

<u>Case#</u>	<u>Length</u>	<u>Width</u>	<u>Requirements</u>
1	19'	9'	Standard painted stall.
2	18'	9'	Standard plus continuous concrete curbs.
3	19'	8-1/2'	Standard plus designated exclusive employee parking.
4	18'	8-1/2'	Standard plus continuous concrete curbs and designated exclusive employee parking.
5	16-1/2'	8-1/2'	Compact painted stall.
6	15-1/2'	8-1/2'	Compact plus continuous concrete curbs.
7	16-1/2'	8'	Compact plus designated exclusive employee parking.
8	15-1/2'	8'	Compact plus continuous concrete curbs and designated exclusive employee parking.

The conditions that must be met in order to define which basic stall size may be used are stated in Section 3 of this manual, page 6.

B. Truck Loading Spaces

A truck loading space shall be an accessible rectangle having a width of 12 feet and a length of 40 feet. Any overhead obstruction shall have a vertical clearance of 15 feet.

2. DESIGN CRITERIA

A. Driveway Approach Construction Standards

Driveway approaches to private property shall be constructed in conformance with the Standard Specifications of the Public Works Department, particularly Drawings **P-1**, **P-2**, **P-3**, and **P-4**, as each may apply. Special driveway approach designs not shown in the Standard Specifications may be approved by the Public Works Department for developments for which more than 200 parking spaces are provided.

Driveway approaches on public streets may not be used to furnish circulation from one row of parking to an adjacent row of parking. This traffic circulation must be provided on private property.

B. Backing onto Public Rights-of-Way

Backing a vehicle onto or from public rights-of-way (public alleys exempt) is prohibited in all areas except residential areas located on streets that are classified as a local street. Parking spaces shall be designed and arranged so that it is more convenient for the parking space user to accomplish the necessary backing movements on the private property than it is to back onto or from the public right of way, where backing is prohibited.

C. Access to Parking Spaces

All parking spaces must have convenient ingress and egress. Access lanes shall be clear and specifically delineated as necessary. (Except in lots with less than 10 parking stalls). All access to individual parking spaces shall be from access lanes (aisles) within the parking facility or from a public alley. Aisle widths are stated on pages 9 through 16 of this manual. Final approval of aisle widths that are designated as fire lanes shall be by the Fresno Fire Department.

Note: An aisle way which provides direct access to parking stalls shall be a one-way aisle, except for parking stalls which are perpendicular or parallel to the aisle way, and where opposing directions are each provided in separate bays (two W-1 bays, see pages 9 through 16) or an opposing aisle is at least 13 feet wide in addition to W-1.

The parking space shall be designed so that the total process of entering and leaving a parking space shall be accomplished in no more movements than two forward and one reverse. No backing maneuver from a parking stall shall conflict or block the public street driveway approach. All such stalls shall be no closer than 20' to the property line at the driveway approach. With the exception of parking facilities having attendant parking, designing of a parking space so as to require the movement of a vehicle to permit entry or exit from another parking space is not permitted.

All required parking spaces shall be available and accessible at all times for vehicular parking purposes.

D. Traffic Circulation Signing and Markings

Directional signs, arrows, and appropriate pavement marking shall be installed to control the direction of traffic flow, when deemed necessary by Public Works Department or the Director of the Development Department.

E. Surface Requirements

All parking areas shall be surfaced in accordance with the Standard Specifications of the Department of Public Works. Reference Public Works Standard **P-21**.

F. Delineation of Parking Spaces

All parking spaces shall be delineated by appropriate fixed curbing, painted lines (a minimum of 4" wide), or other fixed markers. Compact parking stalls or groups of parking stalls shall be individually signed or marked. Any curb painting used to indicate specific use or time limits of parking spaces shall conform to Chapter 10 of the Municipal Code of the City of Fresno.

G. Physical Barriers

Fixed physical barriers shall be installed to protect public and private property adjacent to the parking facility as well as buildings, landscaping, and appurtenances within the development which could be damaged by vehicles using the parking facility. These barriers shall be designed and constructed to facilitate easy cleaning of the parking surface.

A solid masonry wall shall be constructed when required by the zoning ordinance. When no masonry wall is required, wheel stops in the form of a 6" high concrete curb or other approved fixed barrier, placed a minimum distance of 3' from the property line, or the building to be protected, shall be installed. Landscaping shall be adequately protected to avoid damage by vehicles.

Generally, the fixed physical barrier will be placed 3 feet from the property line, or the building to be protected; however, this distance must be a minimum of 5 feet if the vehicles are permitted to back into the parking stalls.

H. Landscaping

Landscaping and irrigation systems shall be installed where required by the Zoning Ordinance or other condition to zoning. For those parking facilities where landscaping is not required, the developer is encouraged to install landscaping to improve the appearance of his premises and of the general neighborhood.

I. Lighting

A lighting system shall be installed on all off-street parking areas. This lighting system shall be designed to produce a minimum maintained average light level of one-half (1/2) foot candle on the entire parking facility's horizontal surface, including the parking spaces, the loading spaces and the vehicular and pedestrian circulation areas.

The system shall have a maximum brightness ratio of 6 to 1.

The lighting fixtures shall be hooded and so arranged and controlled as not to cause a nuisance either to highway traffic or adjacent properties. When the parking facility is open to the public during darkness, this lighting system shall be operating sufficiently to produce the required minimum of one-half (1/2) foot-candle.

All lighting designs are subject to review and approval by the City.

J. Maintenance of Parking Facilities and Equipment

All paving, directional devices and protective equipment, landscaping, and other equipment furnished or required on the parking facility shall be maintained to insure safe pedestrian movement, vehicular operation, adequate protection of adjoining properties, and to present a neat and attractive appearance of the facility.

K. Parking Lot Design

The design of parking lots shall conform to the minimum standards shown on pages 9 through 16.

3. CRITERIA TO DETERMINE BASIC STALL SIZE

A. Any parking lot or structure may use **Case #1** stall dimensions for design.

B. In order to use **Case #2** dimensions a 6" high continuous concrete curb must be used. Concrete wheel stops are not an acceptable substitute. The allowable front vehicle overhang is 3'.

C. To use **Case #3** dimensions 90% of the parking area must be designated for the exclusive use of employees. The 10% of the parking area closest to the main building entrance must be reserved for customer/visitor parking. This 10% must be designed to **Case #1 or #2** standards.

D. **Case #4** dimensions may be used as stated in **Case #3** if a 6" high continuous concrete curb is constructed. Concrete wheel stops are not an acceptable substitute. The allowable front vehicle overhang is 3'.

E. **Case #5** reflects the basic size for small car spaces in lots or structures. 8-1/2' x 16-1/2' is the basic dimension. Up to twenty-five percent (25%) of the parking spaces in any given parking lot in the commercial, industrial, manufacturing, school, or hospital zone districts may be designated for small cars. Other long term parking areas may also be considered by the director. Residential uses may not use small car standards **Cases #5 through #8**. Before any small car standards (**Cases #5 through #8**) are allowed 10 standard size stalls (**Cases #1 through #4**) must be provided. These 10 standard size stalls must be located on the site closest to the main building entrance. 50% of the standard size stalls excluding the required 10 minimum and the required handicap stalls must be located on the site closest to the main entrance (up to 25 spaces). On lots exceeding 70 stalls, 25 standard size and handicap stalls shall be located on the site closest to the main entrance.

F. **Case #6** dimensions may be used with the same criteria stated in Case #5 with the addition of a 6" high continuous concrete curb. Concrete wheel stops are not an acceptable substitute. The allowable front vehicle overhang is 2'.

G. **Case #7** dimensions may be used if 90% of the parking area is designed for the exclusive use of employees. The 10% of parking area closest to the main building entrance must be reserved for customer/visitor parking. This 10% must be designed to Case #1 or #2 standards.

H. **Case #8** dimensions may be used as stated in **Case #7** if a 6" high continuous concrete curb is constructed. Concrete wheel stops are not an acceptable substitute. The allowable front vehicle overhang is 2'.

Access to all spaces shall conform to the parameters outlined in Section 2-C of this manual. If a common space is to be provided serving both small cars and standard size cars, the minimum dimensions for standard cars shall apply.

4. **ACCESSIBLE PARKING STALLS**

Accessible Parking Stalls shall be provided as required in the zoning ordinance. Accessible parking for people with disabilities should be consistent with current State and Federal Guidelines.

For more information about California State requirements for accessible parking, you can visit the California Division of State Architect (DSA) website at:

<http://www.dsa.dgs.ca.gov/Access/default.htm>

You can view the DSA's California Access Compliance Reference Manual (revised June of 2006) at::

http://www.dsa.dgs.ca.gov/Access/ud_accessmanual.htm

checklist for accessible parking at:

http://www.documents.dgs.ca.gov/dsa/pubs/checklists_06-16-06.pdf

The ADA Standards for Accessible Design are available at the US Department of Justice Website:

<http://www.ada.gov/stdspdf.htm>

5. **TABLE OF DESIGN DIMENSION FOR VARIOUS PARKING ANGLES**

(See pages 9-16)

TABLE OF DESIGN DIMENSION FOR VARIOUS PARKING ANGLES
CASE - 1

ANGLE OF PARKING	PARKING BY DIMENSIONS				AISLE WIDTH	DESIGN LAYOUT DIMENSION	
	W-1	W-2	W-3	W -4		P.L.	P.W.
30.0	29.5	46.5	42.5	39.0	12.0	29.9	18.0
35.0	30.5	48.5	45.0	41.0	12.0	26.1	15.7
40.0	31.0	50.0	47.0	43.5	12.0	22.8	14.0
45.0	32.0	51.5	48.5	45.0	12.0	19.8	12.7
50.0	33.5	53.5	51.0	48.0	13.0	17.1	11.8
55.0	33.5	54.5	52.0	49.5	13.0	14.5	11.0
60.0	35.0	56.0	53.5	51.5	14.0	12.1	10.4
65.0	37.0	58.0	56.0	54.0	16.0	9.8	9.9
70.0	39.0	60.0	58.5	57.0	18.0	7.6	9.6
75.0	40.5	61.5	60.0	59.0	20.0	5.5	9.3
80.0	43.5	63.5	63.0	62.0	23.0	3.6	9.1
85.0	44.5	64.5	64.0	63.5	25.0	1.7	9.0
90.0	47.0	65.0	65.0	65.0	27.0	0.0	9.0

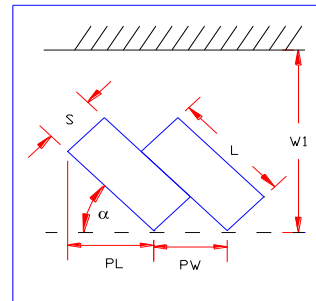
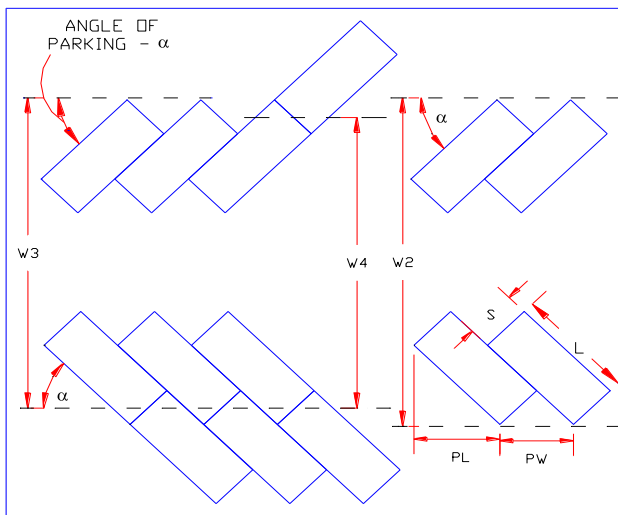

S = 9.0 ft.

L = 19.0 ft.

Note: An aisle way which provides direct access to parking stalls shall be a one-way aisle, except for parking stalls which are perpendicular or parallel to the aisle way.

TABLE OF DESIGN DIMENSIONS FOR VARIOUS PARKING ANGLES
CASE - 2

ANGLE OF PARKING	PARKING BY DIMENSIONS				AISLE WIDTH	DESIGN LAYOUT DIMENSION	
	W-1	W-2	W-3	W-4		P.L.	P.W.
30.0	29.0	45.5	41.5	38.0	12.0	29.1	18.0
35.0	29.5	47.5	43.5	40.0	12.0	25.3	15.7
40.0	30.5	49.0	45.5	42.0	12.0	22.0	14.0
45.0	31.0	50.0	47.0	44.0	12.0	19.1	12.7
50.0	32.5	52.0	49.5	46.5	13.0	16.4	11.8
55.0	33.0	53.0	50.0	47.5	13.0	13.9	11.0
60.0	34.0	54.0	52.0	49.5	14.0	11.6	10.4
65.0	36.0	56.0	54.5	52.5	16.0	9.4	9.9
70.0	38.0	58.0	56.5	55.0	18.0	7.3	9.6
75.0	39.5	59.5	58.5	57.0	20.0	5.3	9.3
80.0	42.5	61.5	61.0	60.0	23.0	3.4	9.1
85.0	43.5	62.5	62.0	61.5	25.0	1.6	9.0
90.0	46.0	63.0	63.0	63.0	27.0	0.0	9.0

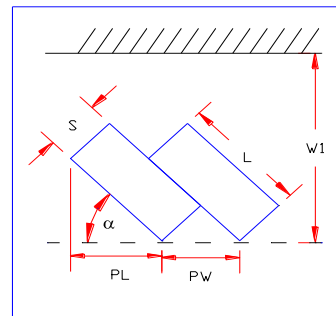
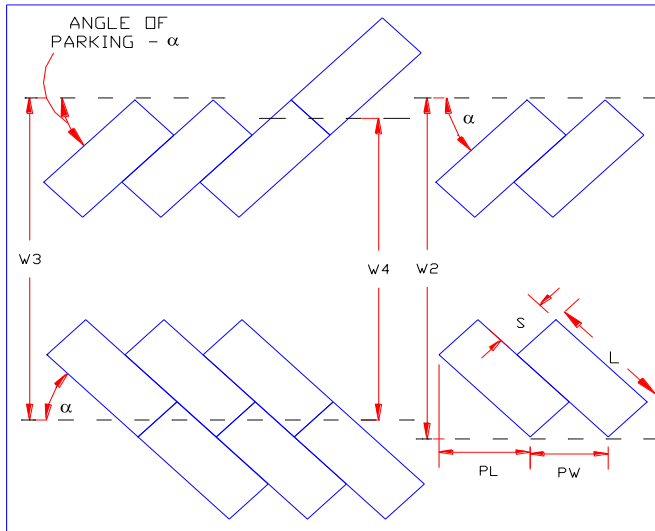

$S = 9.0$ ft.
 $L = 18.0$ ft.

Note: An aisle way which provides direct access to parking stalls shall be a one-way aisle, except for parking stalls which are perpendicular or parallel to the aisle way.

TABLE OF DESIGN DIMENSIONS FOR VARIOUS PARKING ANGLES
CASE -3

ANGLE OF PARKING	PARKING BY DIMENSIONS				AISLE WIDTH	DESIGN LAYOUT DIMENSION	
	W-1	W-2	W-3	W-4		P.L	PW
30.0	29.0	45.5	42.0	38.5	12.0	29.2	17.0
35.0	30.0	47.5	44.0	41.0	12.0	25.5	14.8
40.0	30.5	49.5	46.0	43.0	12.0	22.3	13.2
45.0	31.5	51.0	48.0	45.0	12.0	19.5	12.0
50.0	33.0	53.0	50.5	47.5	13.0	16.8	11.1
55.0	33.5	54.0	51.5	49.0	13.0	14.3	10.4
60.0	34.5	55.5	53.5	51.0	14.0	12.0	9.8
65.0	37.0	57.5	56.0	54.0	16.0	9.7	9.4
70.0	39.0	59.5	58.0	56.5	18.0	7.6	9.1
75.0	40.5	61.0	60.0	59.0	20.0	5.5	8.8
80.0	43.0	63.5	62.5	62.0	23.0	3.6	8.6
85.0	44.5	64.5	64.0	63.5	25.0	1.7	8.5
90.0	47.0	65.0	65.0	65.0	27.0	0.0	8.5

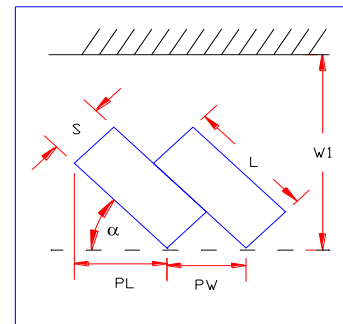
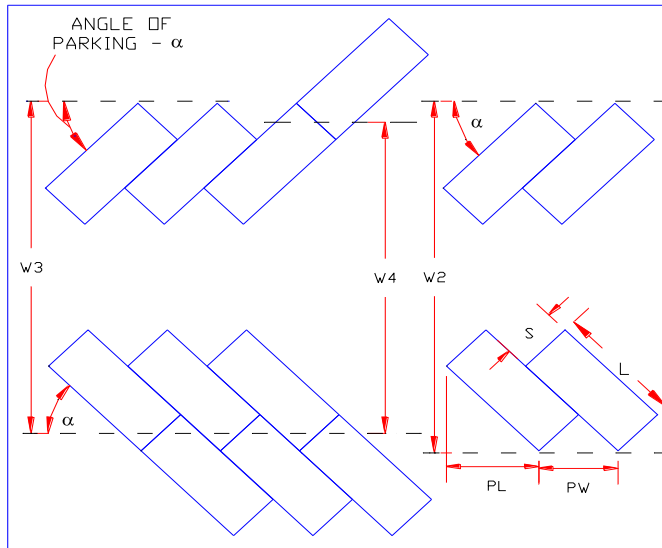

S = 8.5 ft.
L = 19.0 ft.

Note: An aisle way which provides direct access to parking stalls shall be a one-way aisle, except for parking stalls which are perpendicular or parallel to the aisle way.

TABLE OF DESIGN DIMENSIONS FOR VARIOUS PARKING ANGLES
CASE - 4

ANGLE OF PARKING	PARKING BY DIMENSIONS				AISLE WIDTH	DESIGN LAYOUT DIMENSION	
	W-1	W-2	W-3	W-4		P.L.	P.W.
30.0	28.5	44.5	41.0	37.5	12.0	28.3	17.0
35.0	29.5	46.5	43.0	39.5	12.0	24.7	14.8
40.0	30.0	48.0	45.0	41.5	12.0	21.6	13.2
45.0	30.5	49.5	46.5	43.5	12.0	18.7	12.0
50.0	32.5	51.5	49.0	46.0	13.0	16.2	11.1
55.0	32.5	52.0	50.0	47.5	13.0	13.7	10.4
60.0	34.0	53.5	51.5	49.5	14.0	11.5	9.8
65.0	36.0	56.0	54.0	52.0	16.0	9.3	9.4
70.0	38.0	57.5	56.0	54.5	18.0	7.2	9.1
75.0	39.5	59.0	58.0	57.0	20.0	5.3	8.8
80.0	42.0	61.5	60.5	60.0	23.0	3.4	8.6
85.0	43.5	62.5	62.0	61.5	25.0	1.6	8.5
90.0	46.0	63.0	63.0	63.0	27.0	0.0	8.5

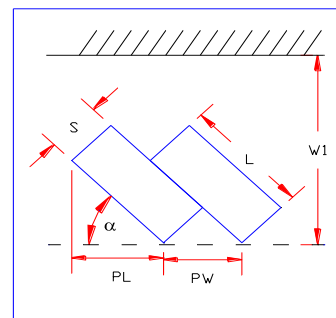
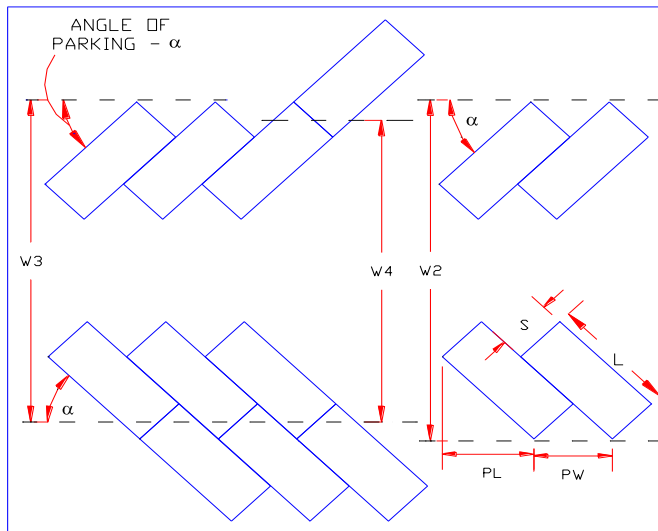

S = 8.5 ft.
L = 18.0 ft.

Note: An aisle way which provides direct access to parking stalls shall be a one-way aisle, except for parking stalls which are perpendicular or parallel to the aisle way.

TABLE OF DESIGN DIMENSIONS FOR VARIOUS PARKING ANGLES
CASE -5

ANGLE OF PARKING	PARKING BY DIMENSIONS				AISLE WIDTH	DESIGN LAYOUT DIMENSION	
	W-1	W-2	W-3	W-4		P.L.	P.W.
30.0	27.5	43.0	39.5	36.0	12.0	27.0	17.0
35.0	28.5	45.0	41.5	38.0	12.0	23.5	14.8
40.0	29.0	46.0	43.0	39.5	12.0	20.4	13.2
45.0	29.5	47.5	44.5	41.5	12.0	17.7	12.0
50.0	31.0	49.0	46.5	43.5	13.0	15.2	11.1
55.0	31.5	50.0	47.5	45.0	13.0	12.9	10.4
60.0	32.5	51.0	49.0	47.0	14.0	10.7	9.8
65.0	34.5	53.0	51.5	49.5	16.0	8.7	9.4
70.0	36.5	55.0	53.5	52.0	18.0	6.7	9.1
75.0	38.0	56.5	55.0	54.0	20.0	4.9	8.8
80.0	40.5	58.5	57.5	57.0	23.0	3.1	8.6
85.0	42.0	59.5	59.0	58.5	25.0	1.5	8.5
90.0	44.5	60.0	60.0	60.0	27.0	0.0	8.5

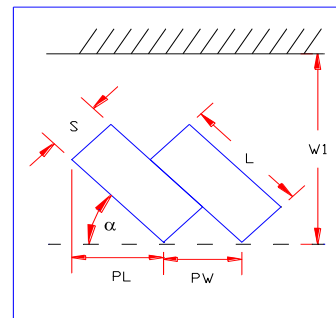
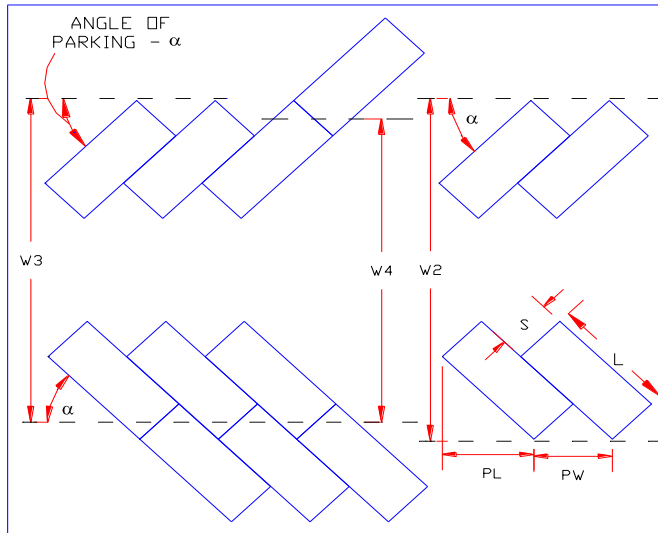

S = 8.5 ft.
L = 16.5 ft.

Note: An aisle way which provides direct access to parking stalls shall be a one-way aisle, except for parking stalls which are perpendicular or parallel to the aisle way.

TABLE OF DESIGN DIMENSIONS FOR VARIOUS PARKING ANGLES
CASE - 6

ANGLE OF PARKING	PARKING BY DIMENSIONS				AISLE WIDTH	DESIGN LAYOUT DIMENSION	
	W-1	W-2	W-3	W-4		P.L.	P.W.
30.0	27.0	42.0	38.5	35.0	12.0	26.2	17.0
35.0	28.0	43.5	40.0	36.5	12.0	22.6	14.8
40.0	28.5	45.0	41.5	38.5	12.0	19.6	13.2
45.0	29.0	46.0	43.0	40.0	12.0	17.0	12.0
50.0	30.5	47.5	45.0	42.0	13.0	14.6	11.1
55.0	30.5	48.0	45.5	43.5	13.0	12.3	10.4
60.0	31.5	49.5	47.0	45.0	14.0	10.2	9.8
65.0	33.5	51.5	49.5	47.5	16.0	8.2	9.4
70.0	35.5	53.0	51.5	50.0	18.0	6.4	9.1
75.0	37.0	54.5	53.0	52.0	20.0	4.6	8.8
80.0	39.5	56.5	55.5	55.0	23.0	3.0	8.6
85.0	41.0	57.5	57.0	56.5	25.0	1.4	8.5
90.0	43.5	58.0	58.0	58.0	27.0	0.0	8.5

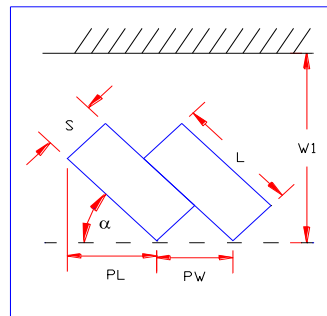
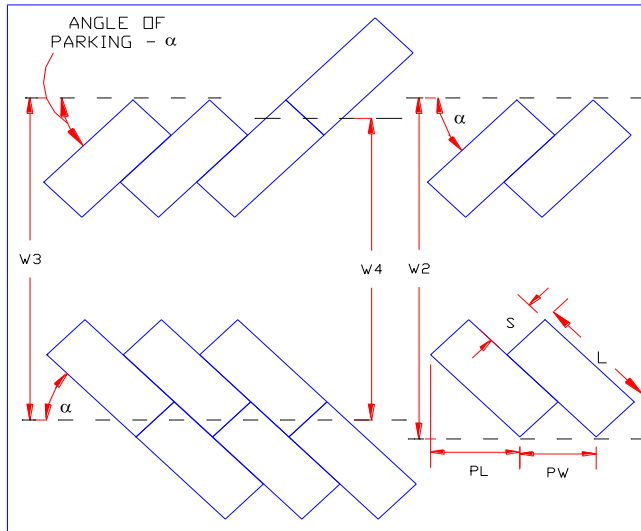

S = 8.5 ft.
L = 15.5 ft.

Note: An aisle way which provides direct access to parking stalls shall be a one-way aisle, except for parking stalls which are perpendicular or parallel to the aisle way.

TABLE OF DESIGN DIMENSIONS FOR VARIOUS PARKING ANGLES
CASE - 7

ANGLE OF PARKING	PARKING BY DIMENSIONS				AISLE WIDTH	DESIGN LAYOUT DIMENSION	
	W-1	W-2	W-3	W-4		P.L.	P.W.
30.0	27.0	42.5	39.0	35.5	12.0	26.3	16.0
35.0	28.0	44.0	41.0	37.5	12.0	22.9	14.0
40.0	28.5	45.5	42.5	39.5	12.0	19.9	12.5
45.0	29.5	46.5	44.0	41.0	12.0	17.3	11.3
50.0	31.0	48.5	46.0	43.5	13.0	14.9	10.4
55.0	31.0	49.0	47.0	44.5	13.0	12.7	9.8
60.0	32.5	50.5	48.5	46.5	14.0	10.6	9.2
65.0	34.5	52.5	51.0	49.5	16.0	8.6	8.8
70.0	36.0	54.5	53.0	51.5	18.0	6.6	8.5
75.0	38.0	56.0	55.0	54.0	20.0	4.8	8.3
80.0	40.5	58.5	57.5	57.0	23.0	3.1	8.1
85.0	42.0	59.5	59.0	58.5	25.0	1.5	8.0
90.0	44.5	60.0	60.0	60.0	27.0	0.0	8.0

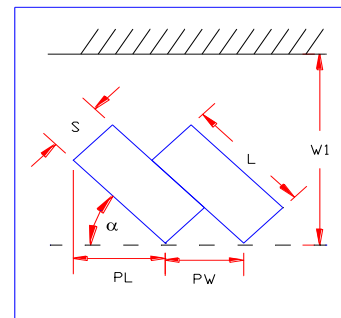
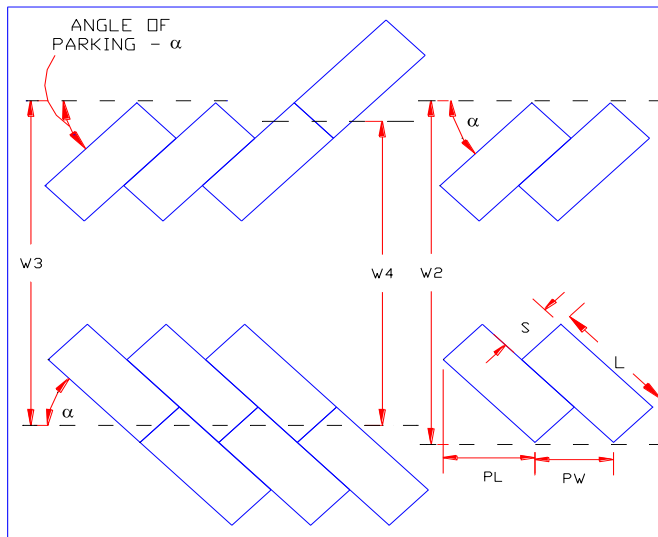

S = 8.0 ft.
L = 16.5 ft.

Note: An aisle way which provides direct access to parking stalls shall be a one-way aisle, except for parking stalls which are perpendicular or parallel to the aisle way.

TABLE OF DESIGN DIMENSIONS FOR VARIOUS PARKING ANGLES
CASE - 8

ANGLE OF PARKING	PARKING BY DIMENSION				AISLE WIDTH	DESIGN LAYOUT DIMENSION	
	W-1	W-2	W-3	W-4		P.L.	P.W.
30.0	26.5	41.5	38.0	34.5	12.0	25.4	16.0
35.0	27.5	43.0	39.5	36.5	12.0	22.1	14.0
40.0	28.0	44.0	41.0	38.0	12.0	19.2	12.5
45.0	28.5	45.0	42.5	39.5	12.0	16.6	11.3
50.0	30.0	47.0	44.5	42.0	13.0	14.3	10.4
55.0	30.5	47.5	45.5	43.0	13.0	12.1	9.8
60.0	31.5	49.0	47.0	45.0	14.0	10.1	9.2
65.0	33.5	51.0	49.0	47.5	16.0	8.1	8.8
70.0	35.5	52.5	51.0	50.0	18.0	6.3	8.5
75.0	37.0	54.0	53.0	52.0	20.0	4.6	8.3
80.0	39.5	56.5	55.5	55.0	23.0	2.9	8.1
85.0	41.0	57.5	57.0	56.5	25.0	1.4	8.0
90.0	43.5	58.0	58.0	58.0	27.0	0.0	8.0

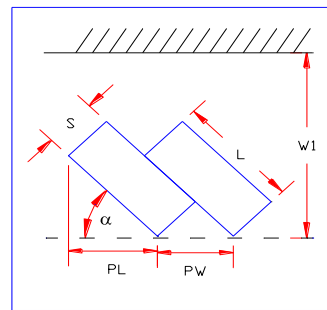
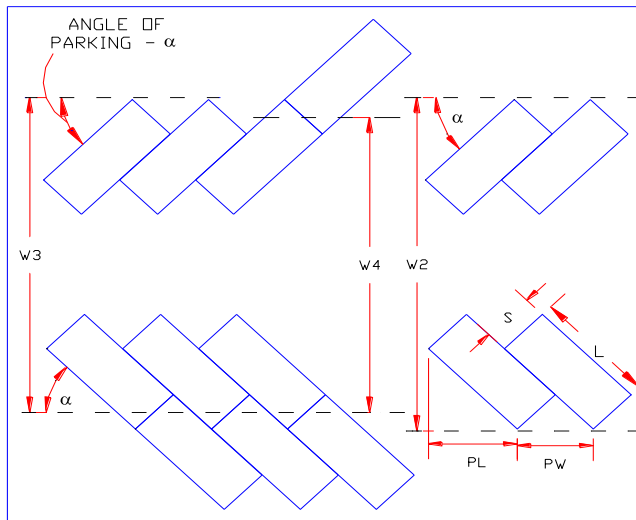

S = 8.0 ft.
L = 15.5 ft.

Note: An aisle way which provides direct access to parking stalls shall be a one-way aisle, except for parking stalls which are perpendicular or parallel to the aisle way.

6. PARALLEL PARKING DESIGN DIMENSIONS (STANDARD STALLS)

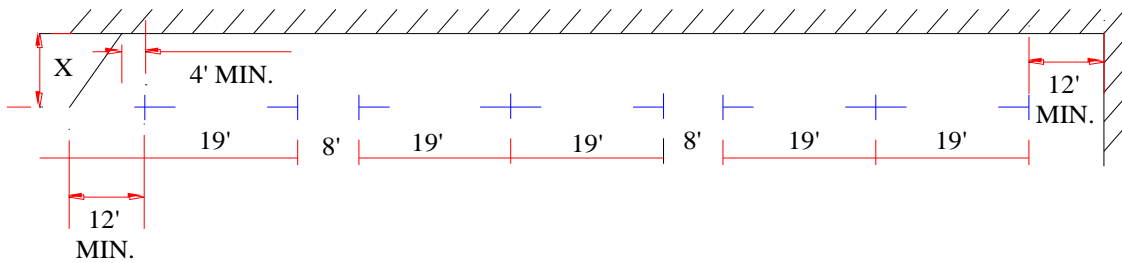
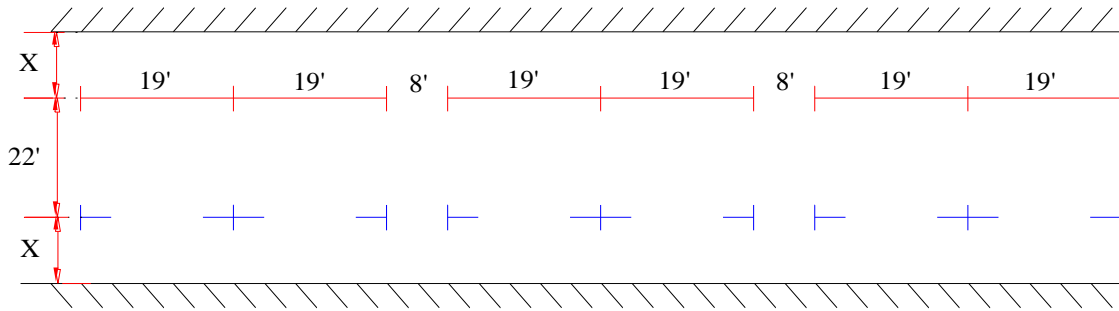

X = 10' IF ADJACENT TO AN OBSTRUCTION OVER 8" HIGH SUCH AS A WALL OR FENCE.

X = 8' IF ADJACENT TO A SIDEWALK OR SIMILAR BARRIER LESS THAN 8" HIGH AND AT LEAST 2' WIDE.

NOTE: MINIMUM ONE-WAY AISLE - 13'
MINIMUM TWO-WAY AISLE - 22'

7. FULL-TURN DETAIL FOR 65° PARKING ANGLE OR LESS

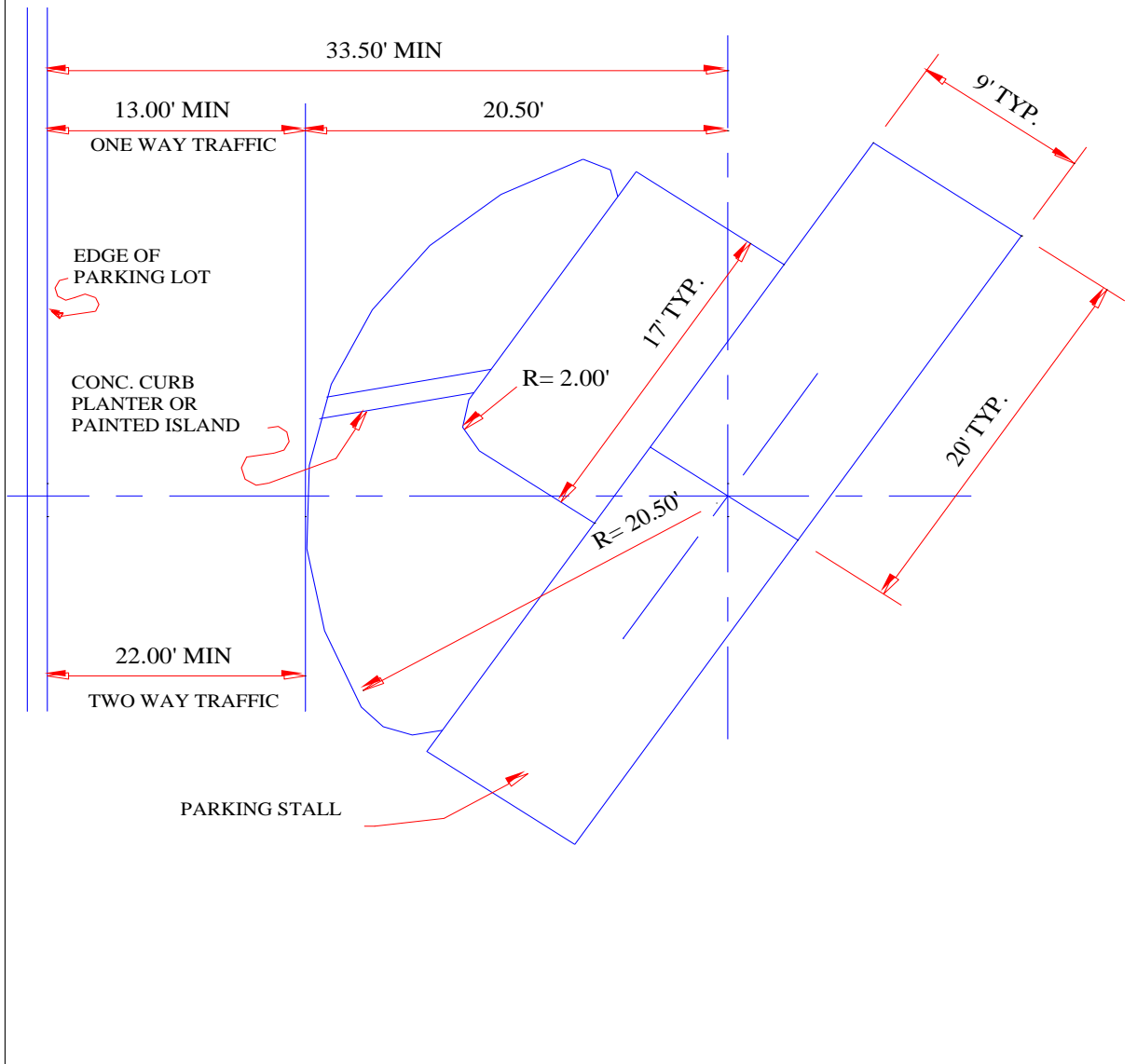

8. FULL-TURN DETAIL FOR MORE THAN 65° PARKING (STANDARD STALLS)

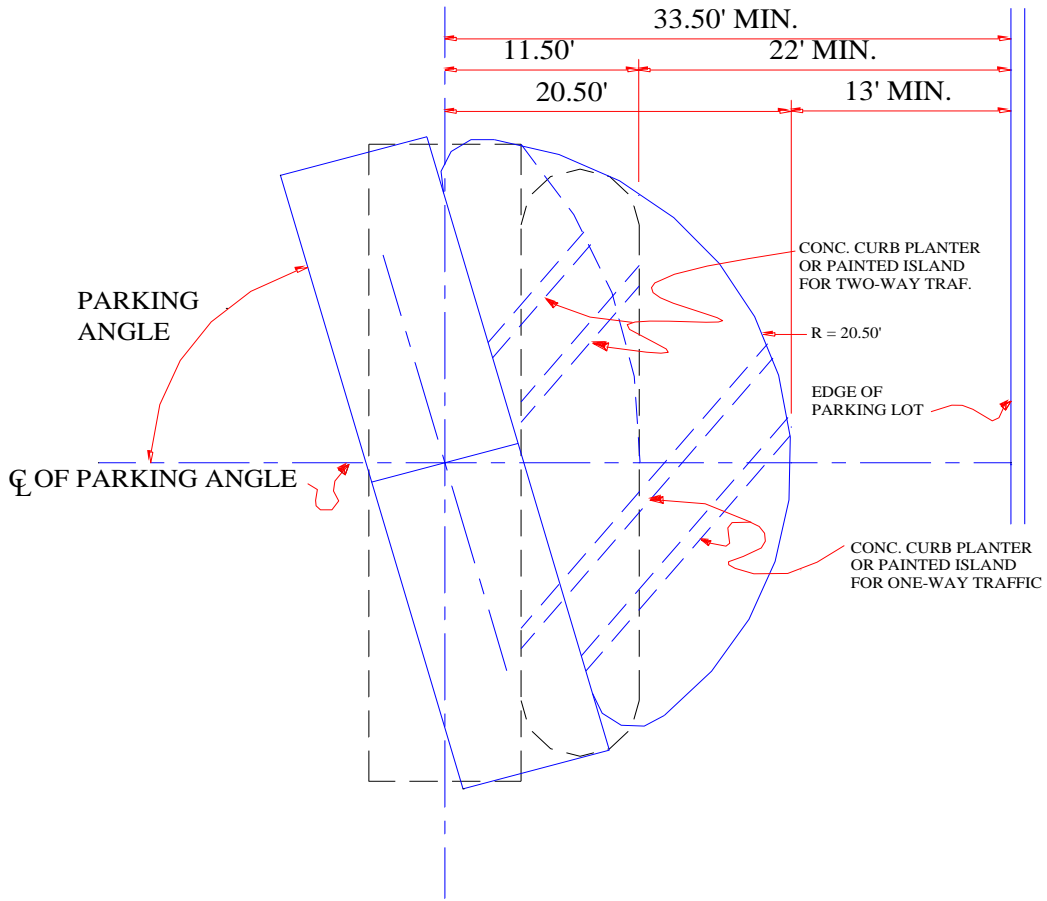

Parking Manual – Part I

Accessible parking for people with disabilities should be consistent with current State and Federal Guidelines.

For more information about California State requirements for accessible parking, you can visit the California Division of State Architect (DSA) website at: <http://www.dsa.dgs.ca.gov/Access/default.htm>. You can view the DSA's California Access Compliance Reference Manual (revised June of 2006) at http://www.dsa.dgs.ca.gov/Access/ud_accessmanual.htm, and a checklist for accessible parking at: http://www.documents.dgs.ca.gov/dsa/pubs/checklists_06-16-06.pdf.

The ADA Standards for Accessible Design are available at the US Department of Justice Website: <http://www.ada.gov/stdspdf.htm>.